

Dell Bluetooth Keyboard Folio WK415 User's Manual

Regulatory model: K07M
Regulatory type: K07M001



Copyright © 2014 Dell Inc. All rights reserved.

This product is protected by U.S. and international copyright and intellectual property laws. Dell™ and the Dell logo are trademarks of Dell Inc. in the United States and/or other jurisdictions. All other marks and names mentioned herein may be trademarks of their respective companies.

Contents

Features	5
Set Up Your Keyboard	6
Install the Batteries	8
Shortcut Keys	8
Specifications	9
Troubleshooting	10
Keyboard is not turning on	10
Unable to pair to the tablet11
Reconnecting the keyboard11

Features

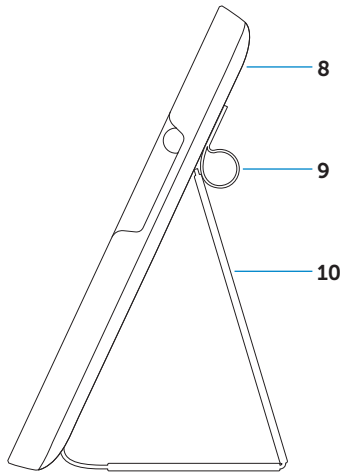
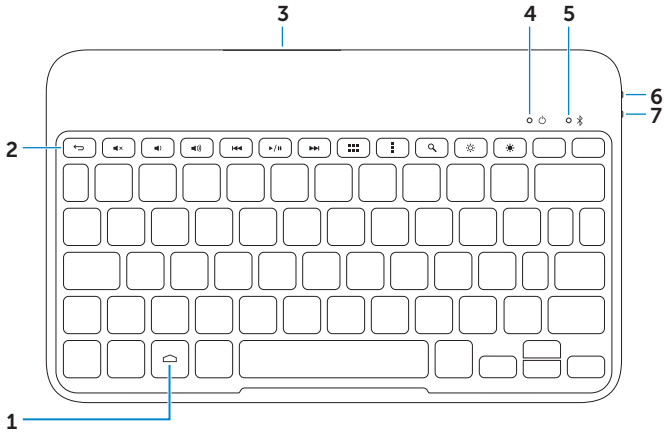

Part	Functionality
1 Home key	Press to go to the home screen.
2 Shortcut keys	Provide quick access to some of the commonly used functions. For more information, see "Shortcut Keys".
3 Battery tray	Allows to install batteries.

4	Power-status light	<ul style="list-style-type: none"> • Turns on for 10 seconds when you turn on the keyboard. • Blinking light indicates low battery.
5	Bluetooth-status light	<ul style="list-style-type: none"> • Turns on for 30 seconds when you turn on the Bluetooth. • Turns on for 60 seconds when the keyboard is in pairing mode.
6	Bluetooth button	<ul style="list-style-type: none"> • Press to turn on the Bluetooth. • Press for 3 seconds to enable pairing mode.
7	Power switch	Slide to turn on the keyboard.
8	Tablet case	Protects your tablet and can be used as a stand.
9	Stylus holder	Holds the stylus.
10	Tablet stand/ Flip cover	Allows to use as a stand or a flip cover.

Set Up Your Keyboard

1. Pull out the insulation strip and slide the power switch.

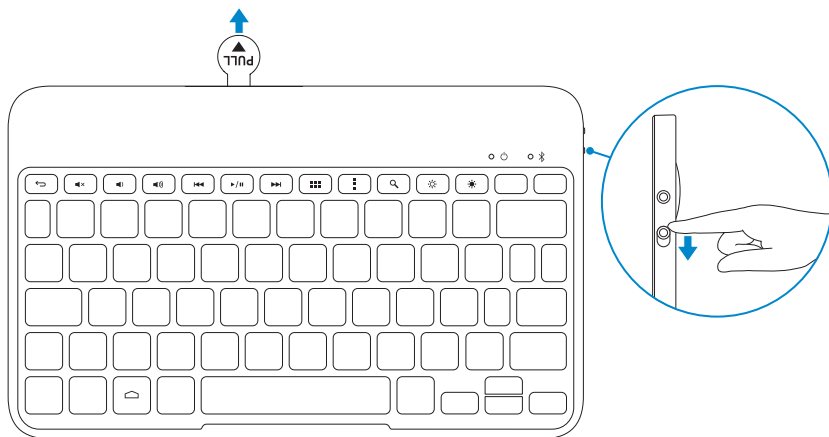

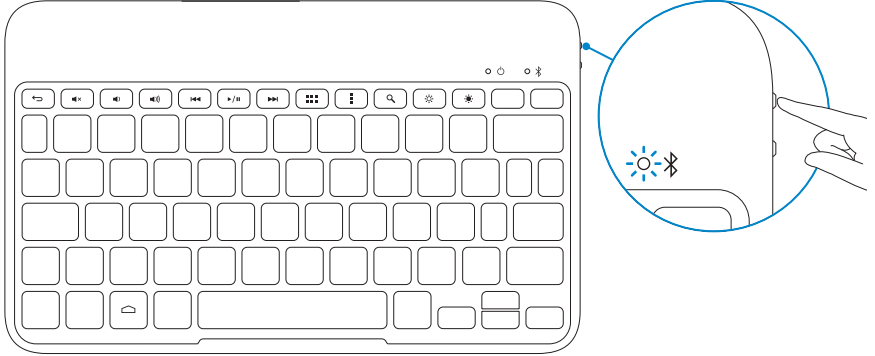

2. Press the Bluetooth button for 3 seconds to enable pairing mode.

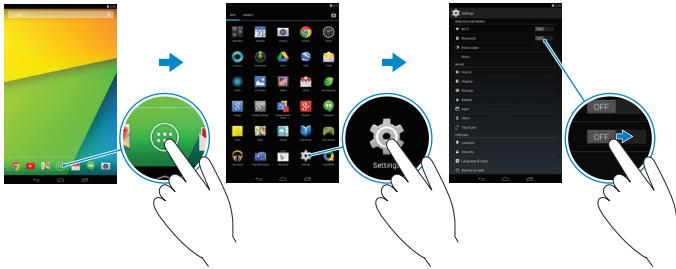

3. Pair the keyboard.



- a. On your tablet, tap  → **Settings**  → **WIRELESS & NETWORKS** → **Bluetooth**.
- b. Enable Bluetooth by moving the slider to **ON** position.
- c. Tap **Bluetooth**.
- d. Tap **Dell WK415 Keyboard**.
- e. Follow the instructions on the screen.

Install the Batteries





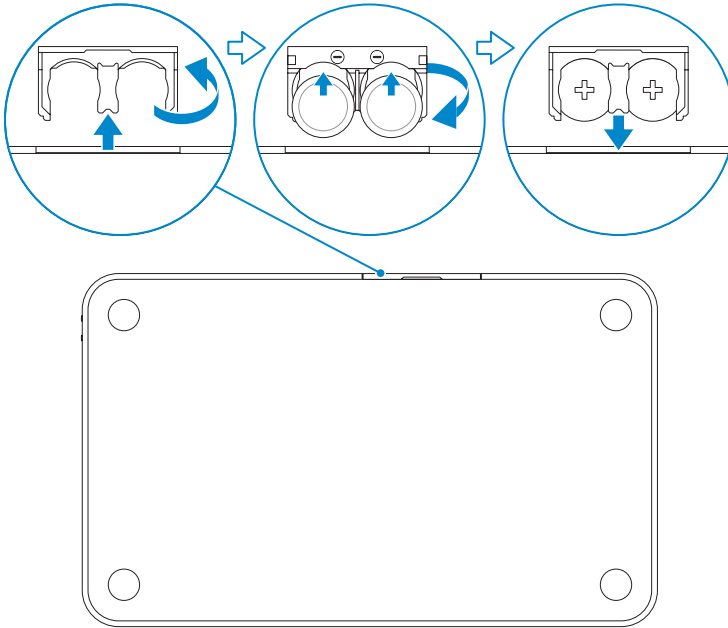

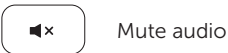

To install the batteries:

1. Carefully pry out the battery tray.
2. Turn the battery tray over.
3. With the batteries' positive side facing you, slide the batteries into the battery slots.
4. Turn the battery tray over.
5. Slide the battery tray into the slot on the keyboard.



Shortcut Keys



-  Increase volume
-  Play previous track/chapter
-  Play/Pause
-  Play next track/chapter
-  All apps
-  Action menu
-  Search
-  Decrease brightness
-  Increase brightness

Specifications

Keyboard Information

Marketing name	Dell Bluetooth Keyboard Folio WK415
Regulatory model	K07M
Regulatory type	K07M001
Connection type	Bluetooth Low Energy (BLE)
Supported operating system	Android 4.4 or later

Dimensions and Weight

Height	20 mm (0.79 inch)
Width	231 mm (9.09 inches)
Depth	135 mm (5.31 inches)
Weight (with tablet case)	0.40 kg (0.88 lb)

Communication

Type	Bluetooth Low Energy (BLE)
Operating range	Up to 10 meters
Operating voltage	3.0 VDC
Operating current	20 mA
Power consumption when Bluetooth is on	750 μ A

Batteries

Slots	Two
Type	Coin-cell non-rechargeable battery
Life span (approximate)	12 months
Operating voltage	2.5 V–3.0 V

Keyboard Environment

Operating temperature	0°C to 60°C
Storage temperature	-40°C to 70°C
Operating humidity (maximum)	90% relative humidity, non-condensing
Storage humidity (maximum)	95% relative humidity, non-condensing

Troubleshooting

Check for the following symptoms and solutions if you are experiencing problems connecting the keyboard to your tablet.

Keyboard is not turning on

1. Check if the insulation strip is removed.
2. Check if the batteries are installed properly.
3. Try replacing the batteries with new batteries.
4. Slide the power switch on the keyboard and make sure the power-status light turns on.

Unable to pair to the tablet

1. Check if the keyboard is turned on.
2. Check if the keyboard Bluetooth-status light is on.
3. Press the Bluetooth button on the keyboard for 3 seconds to enable pairing mode. The Bluetooth-status light turns on for 60 seconds.
4. Check if the Bluetooth on your tablet is turned on. For instructions on turning on Bluetooth on your tablet, see the documentation that shipped with your tablet.
5. Check if you are using a Dell tablet with Android 4.4 or later installed.
6. Check if you have paired to **Dell WK415 Keyboard**.

Reconnecting the keyboard

When the keyboard is connected and there is no action in the tablet when the keyboard keys are pressed:

1. Unpair the keyboard. For instruction on unpairing a Bluetooth device, see the document that shipped with the tablet.
2. Turn off Bluetooth on your tablet. For instructions on turning off the Bluetooth, see the document that shipped with the tablet.
3. Wait for 20 seconds and turn on Bluetooth on your tablet. For instructions on turning on Bluetooth, see the document that shipped with the tablet.
4. Press the Bluetooth button for 3 seconds on the keyboard to enable pairing mode. The Bluetooth-status light turns on for 60 seconds.
5. Tap **Dell WK415 Keyboard** from the list of available devices. Follow the instructions on the screen to pair with the keyboard. Check if the keyboard is working.